

TECHSPEC® 0.345X CobaltTL Telecentric Lens

#15-870



TECHSPEC® CobaltTL Telecentric Lenses are designed for semiconductor and electronics inspection, measurement, and gauging applications. These telecentric lenses achieve high light throughput with industry leading low $f/\#$ s. Featuring less than 0.015° telecentricity and low 0.013% distortion, these lenses are ideal for image stitching applications. These 17.6mm diagonal sensor format lenses are compatible with the Sony IMX304 1.1" sensors and other similar format sensors such as the Sony IMX183. TECHSPEC® CobaltTL Telecentric Lenses produce unparalleled levels of contrast yielding maximum image quality with the highest degree of measurement accuracy. In-line versions provide the ability to rotate/reposition the inline illumination port to allow for maximum flexibility when machine building. TECHSPEC® CobaltTL Telecentric Lenses are compatible with high vibration environments and feature a removable recessed set screw for securely locking the iris in place.

Flange Distance (mm):	17.5
Coating:	425 - 675nm BBAR
Depth of Field (mm):	±8.87mm at f/10 (20% @ 20 lp/mm)

Optical

Horizontal Field of View, 1/2" Sensor:	23.22mm
Horizontal Field of View, 2/3" Sensor:	31.93mm
Horizontal Field of View, 1" Sensor:	46.44mm
Numerical Aperture NA, Object Side:	0.034
Horizontal Field of View, 1.1" Sensor:	40.88mm
Horizontal Field of View, 1/1.8" Sensor:	26.12mm
Typical Telecentricity @ 588nm (°):	<0.094
Typical Distortion @ 588nm (%):	<0.088
Primary Magnification PMAG:	0.345X
Maximum Sensor Format:	1.1"
Working Distance (mm):	114
Aperture (f/#):	f/5 - f/16
FOV @ Max Sensor Format, H x V (mm):	40.88 x 30.65
Lens Wavelength Range:	VIS

Mechanical

Length (mm):	195.50
Filter Thread:	M67 x 0.75 (Female)
Maximum Diameter (mm):	70.0
Number of Elements (Groups):	9 (7)
Mount:	C-Mount

General

Stock No. of Mounting Clamp:	#63-233 - Sold Separately
Type:	Telecentric Lens



#15-870, 0.345X CobaltTTL Telecentric Lens, Distortion Plot

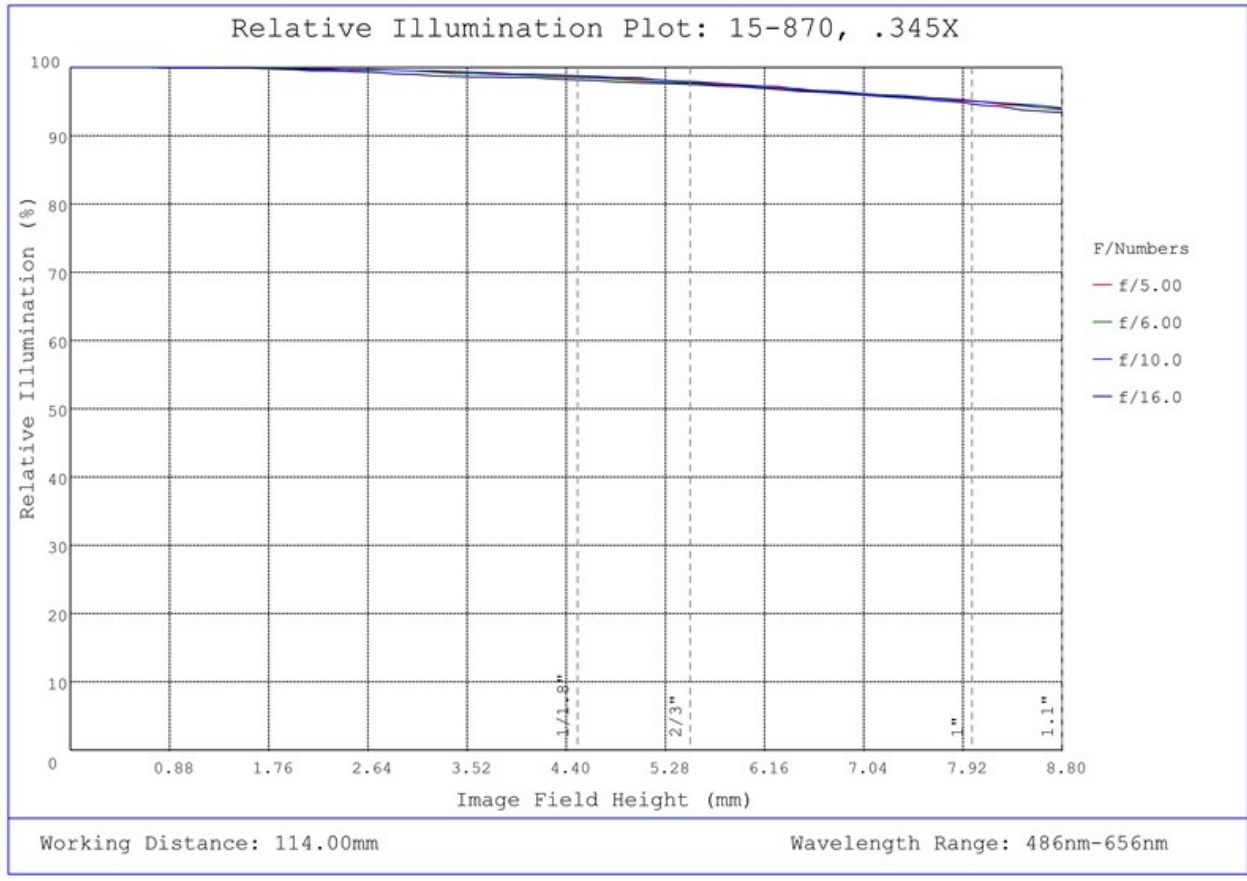

#15-870, 0.345X CobaltTL Telecentric Lens, Relative Illumination Plot

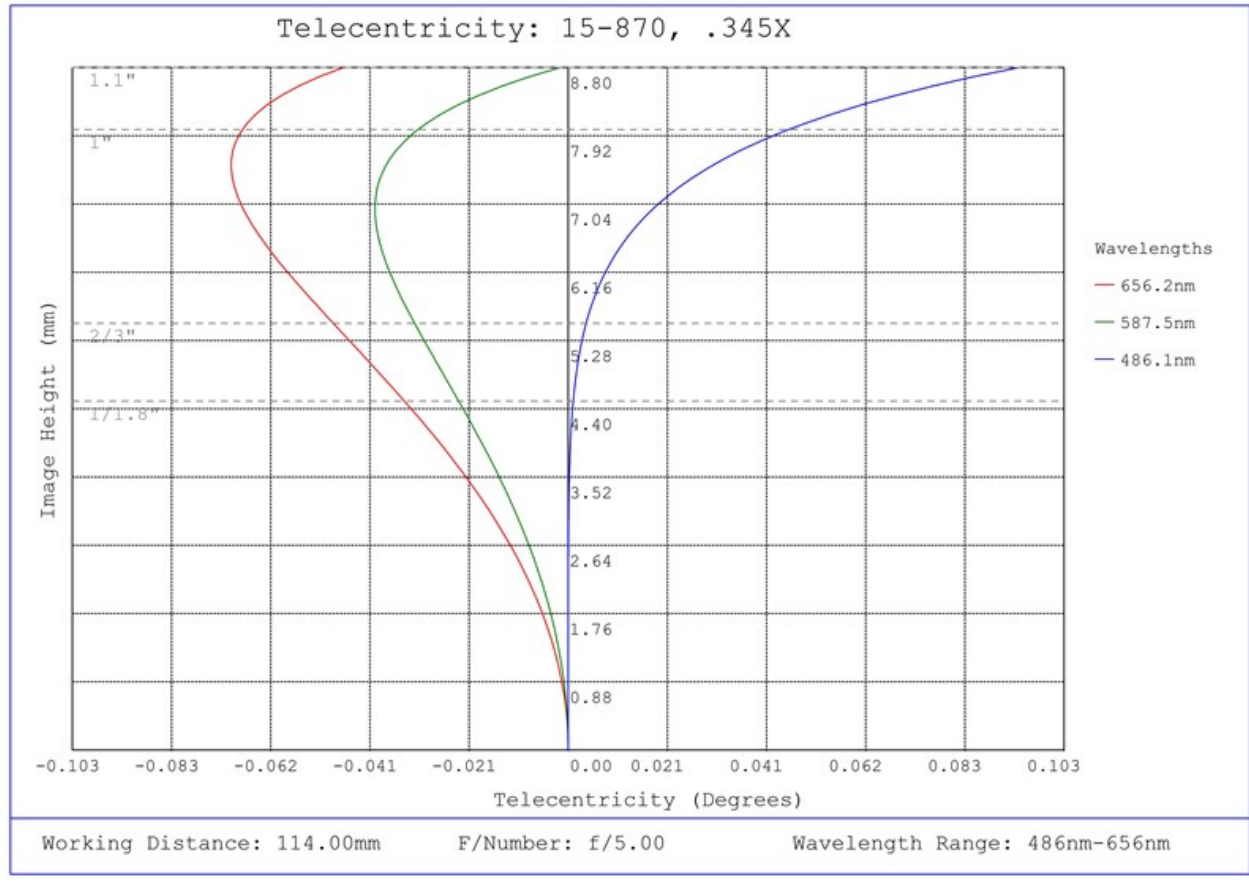

#15-870, 0.345X CobaltTL Telecentric Lens, Telecentricity Plot

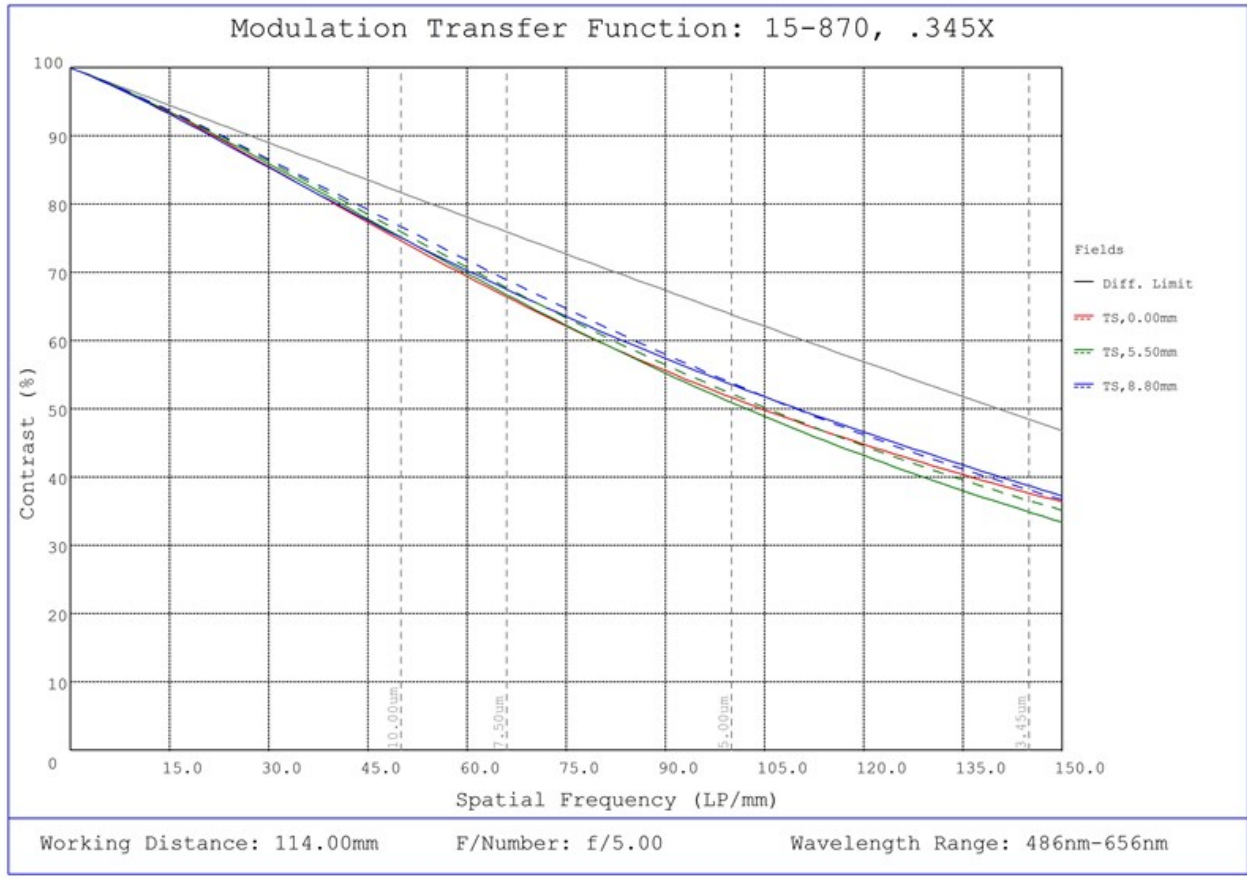

#15-870, 0.345X CobaltTL Telecentric Lens, Modulated Transfer Function (MTF) Plot, 114mm Working Distance, f5

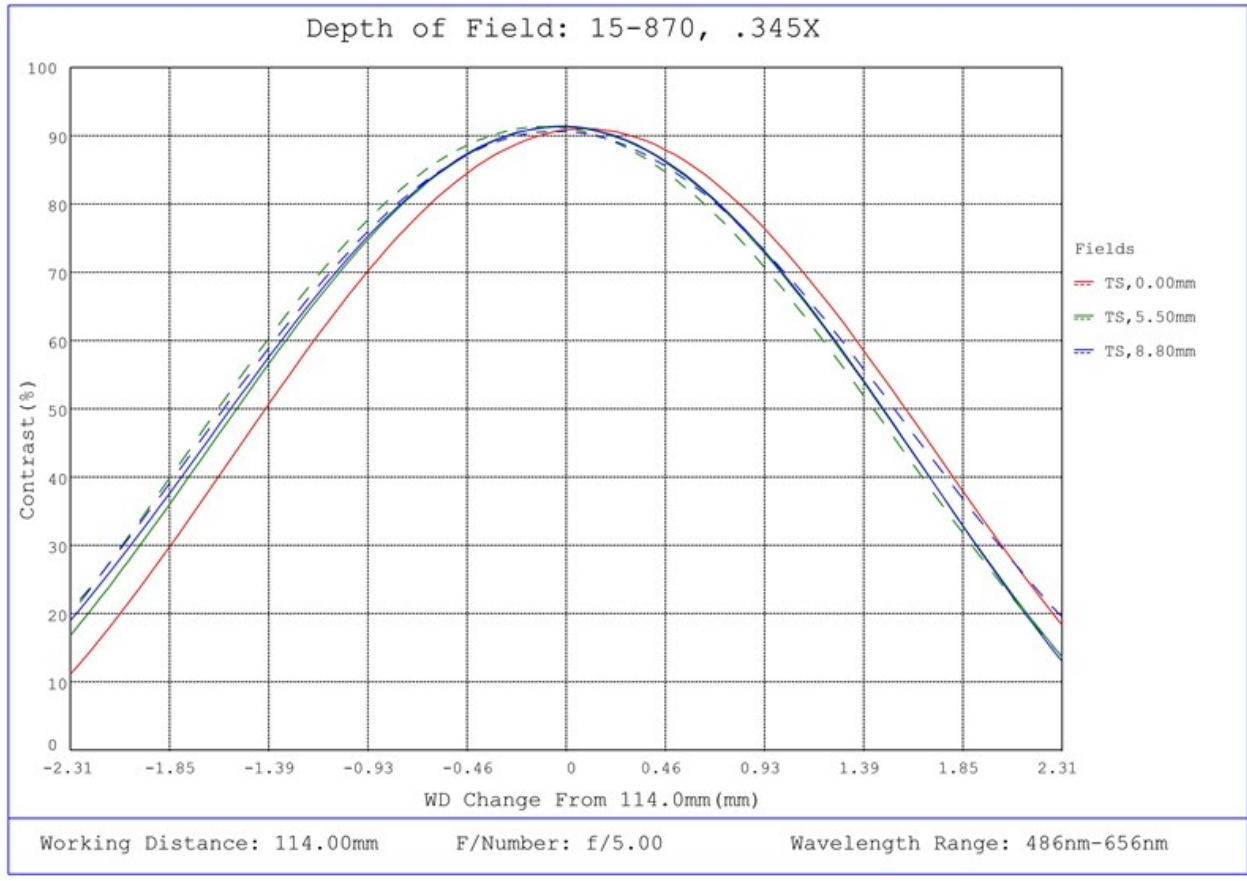

#15-870, 0.345X CobaltTL Telecentric Lens, Depth of Field Plot, 114mm Working Distance, f5

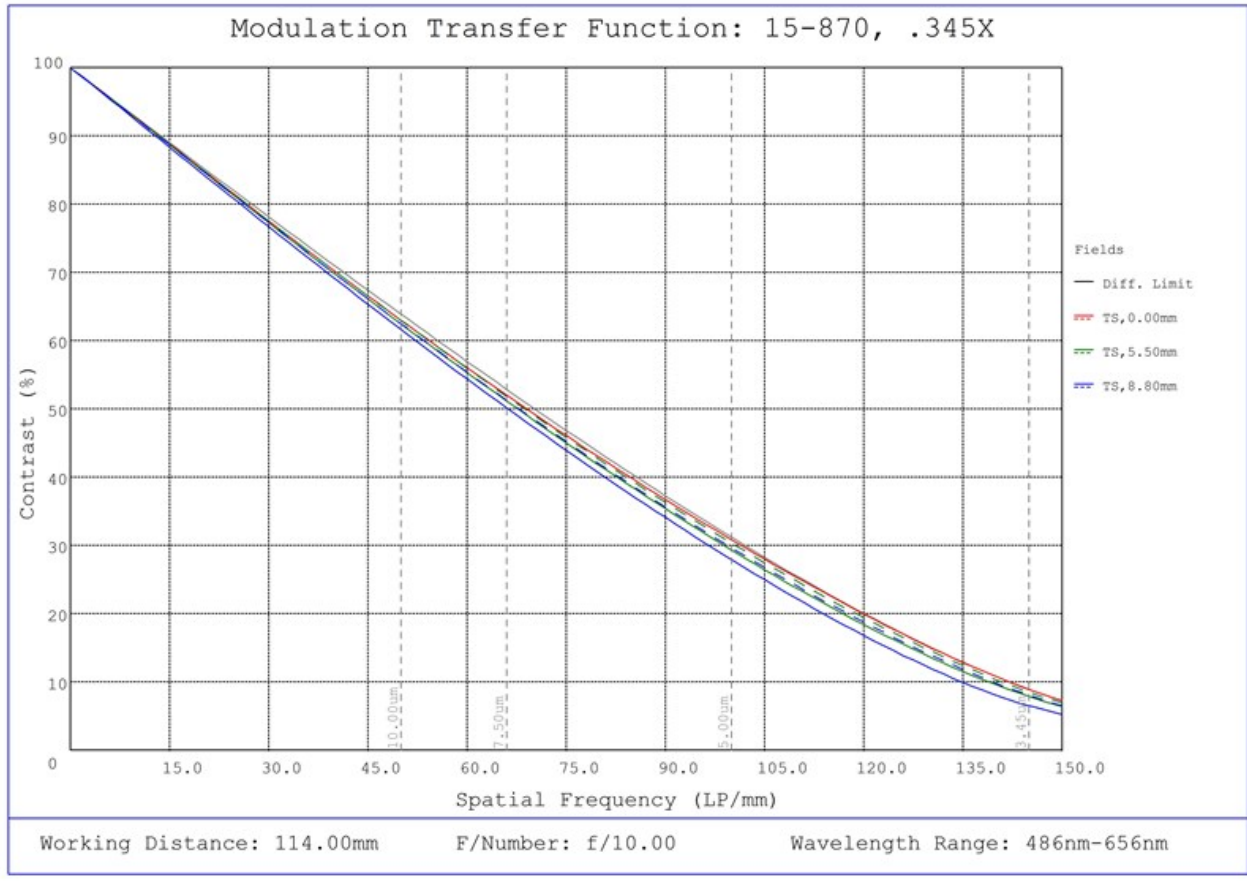

#15-870, 0.345X CobaltTL Telecentric Lens, Modulated Transfer Function (MTF) Plot, 114mm Working Distance, f10

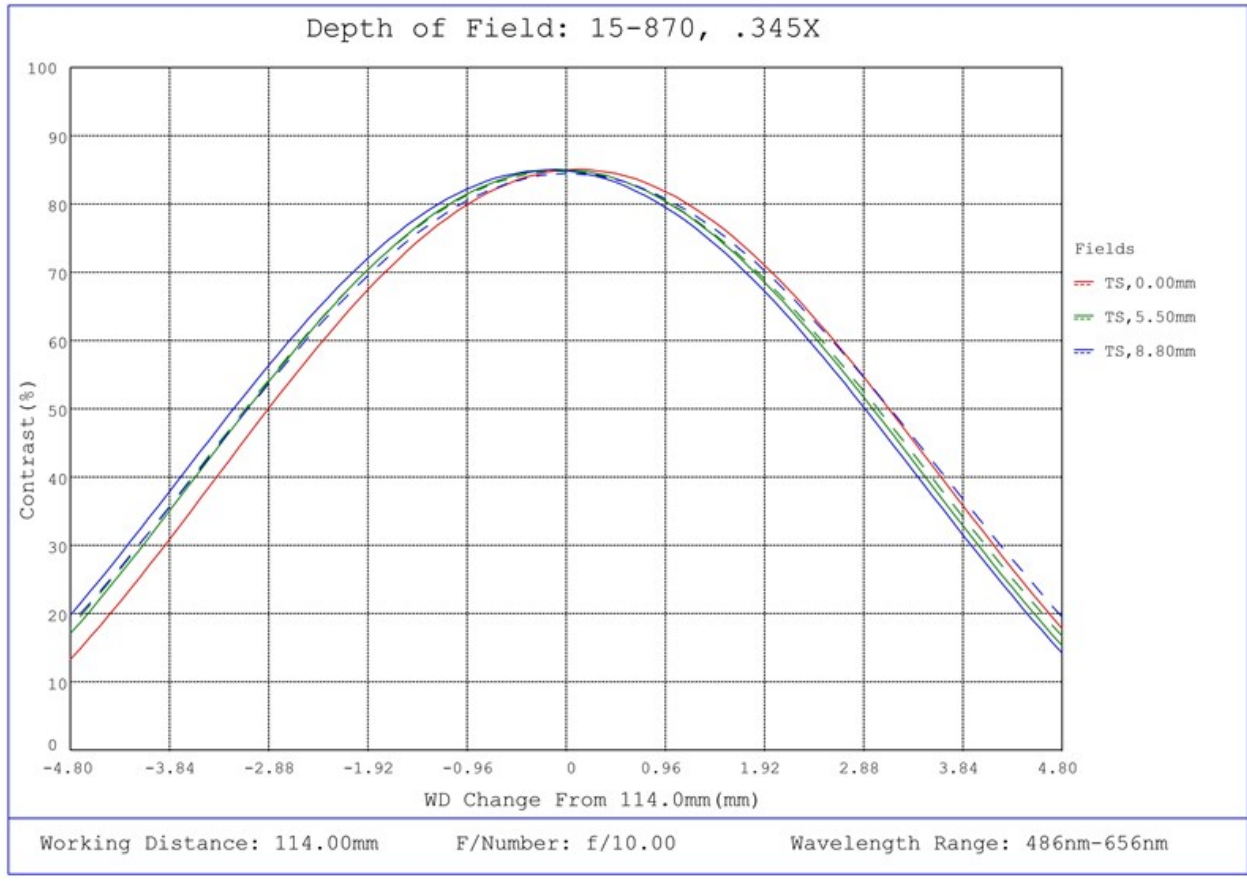

#15-870, 0.345X CobaltTTL Telecentric Lens, Depth of Field Plot, 114mm Working Distance, f10



September 08, 2023

To Whom It May Concern,

This document certifies that the product stated below has been reviewed as requested by Edmund Optics:

<i>Stock No.</i>	<i>Description</i>
15-870	0.345X CobaltTL Telecentric Lens

This item is EU RoHS (2011/65/EU) compliant without the use of exemptions.

This certification means that:

- EO's suppliers have confirmed the material composition of this product.
- EO has implemented rigorous procedures to document this compliance.
- The information provided may, or may not, be based upon actual test data, or on information from our Vendors, Raw Material Suppliers or Subcontractors.



Jay Budd, Director of Corporate Compliance
September 08, 2023

Edmund Optics Inc. - 101 E Gloucester Pike, Barrington, NJ 08007 | 1-800-363-1992 | Compliance@edmundoptics.com



September 08, 2023

<i>Stock No.</i>	<i>Description</i>
15-870	0.345X CobaltTL Telecentric Lens

Edmund Optics certifies that all articles included in this shipment are in compliance with the terms and conditions of this order. The company also certifies that the articles included in this shipment are in accordance to all agreed upon specifications and quality assurance provisions. Please call 1-800-363-1992 should any questions arise from this shipment.



Jeff Harvey- EVP of Operations

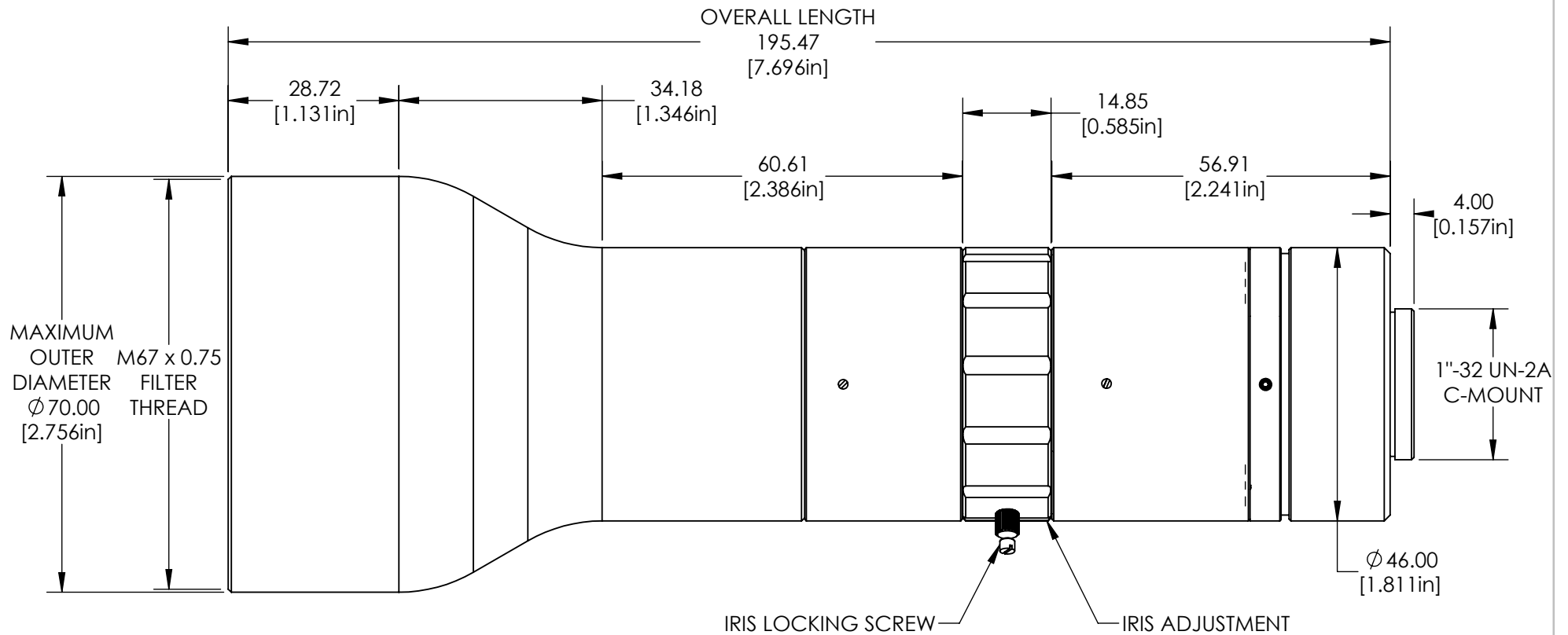

**FOR INFORMATION ONLY:
DO NOT MANUFACTURE
PARTS TO THIS DRAWING**

SPECIFICATIONS SUBJECT TO
CHANGE WITHOUT NOTICE
DIMENSIONS ARE FOR
REFERENCE ONLY

EO® Edmund Optics®

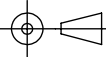
THIRD ANGLE PROJECTION 		TITLE	0.345X CobaltTL Telecentric Lens	
ALL DIMS IN	mm	DWG NO	15870	SHEET 1 OF 1