

TECHSPEC® 12.5mm FL f/5.6, Blue Series M12 Lens

#83-942



12.5mm FL Blue Series M12 Lens

TECHSPEC® Blue Series M12 Lenses feature high resolution performance, along with the same great versatility of our [TECHSPEC® Green Series M12 Lenses](#). Each lens consists of several precision glass elements mounted in a compact, aluminum housing. These lenses can connect to C-Mount cameras using the M12 x 0.5 Adapter for C-Mount Cameras ([#53-675](#)) or the M12 x 0.5 C-Mount Adapter with Rubber O-Ring ([#59-241](#)) for vibration-sensitive environments. TECHSPEC® Blue Series M12 Lenses are ideal for automotive, industrial, and medical imaging application. Prescription data is available by submitting a [Request for Prescription Form](#).

Note: Compatible [TECHSPEC® M12 Imaging Lens Accessories](#) available.

Outer Diameter (mm):	15.0
Wavelength Range (nm):	400 - 700
Back Focal Length BFL (mm):	10.1 - 9.7
IR Cut Filter:	No
Imaging Lens Type:	High Performance M12 Lens

Optical

Horizontal Field of View, 1/2" Sensor:	78.0mm - 28.8°
Horizontal Field of View, 1/3" Sensor:	58.4mm - 21.8°
Maximum Image Circle (mm):	8.00
Numerical Aperture NA, Object Side:	0.0068
Horizontal Field of View @ Max Sensor Format:	78.0mm - 28.8°
Horizontal Field of View, 1/2.5" Sensor:	70.6mm - 26.2°
Focal Length FL (mm):	12.50
Primary Magnification PMAG:	0.082X
Maximum Sensor Format:	1/2"
Working Distance (mm):	150 - ∞
Aperture (f/#):	f/5.6
Distortion (%):	-0.36 @ Full Field
Coating Specification:	λ/4 MgF ₂ @ 550nm
Entrance Pupil Position (mm):	10.87
Horizontal Field of View, 1/4" Sensor:	43.8mm - 16.4°
Object Space Principal Plane (mm):	10.14
Image Space Principal Plane (mm):	-3.01
Field of View at Max Sensor Format:	Horizontal: 78.1mm - 28.9° Vertical: 58.5mm - 21.8° Diagonal: 97.7mm - 35.7°
Exit Pupil Position (mm):	-2.33
Lens Wavelength Range:	VIS

Mechanical

Length (mm):	22.90
Maximum Diameter (mm):	15
Weight (g):	6
Number of Elements (Groups):	5(5)
Mount:	M12 x 0.5 (S-Mount)

General

Type:	M12 Imaging Lens
-------	------------------

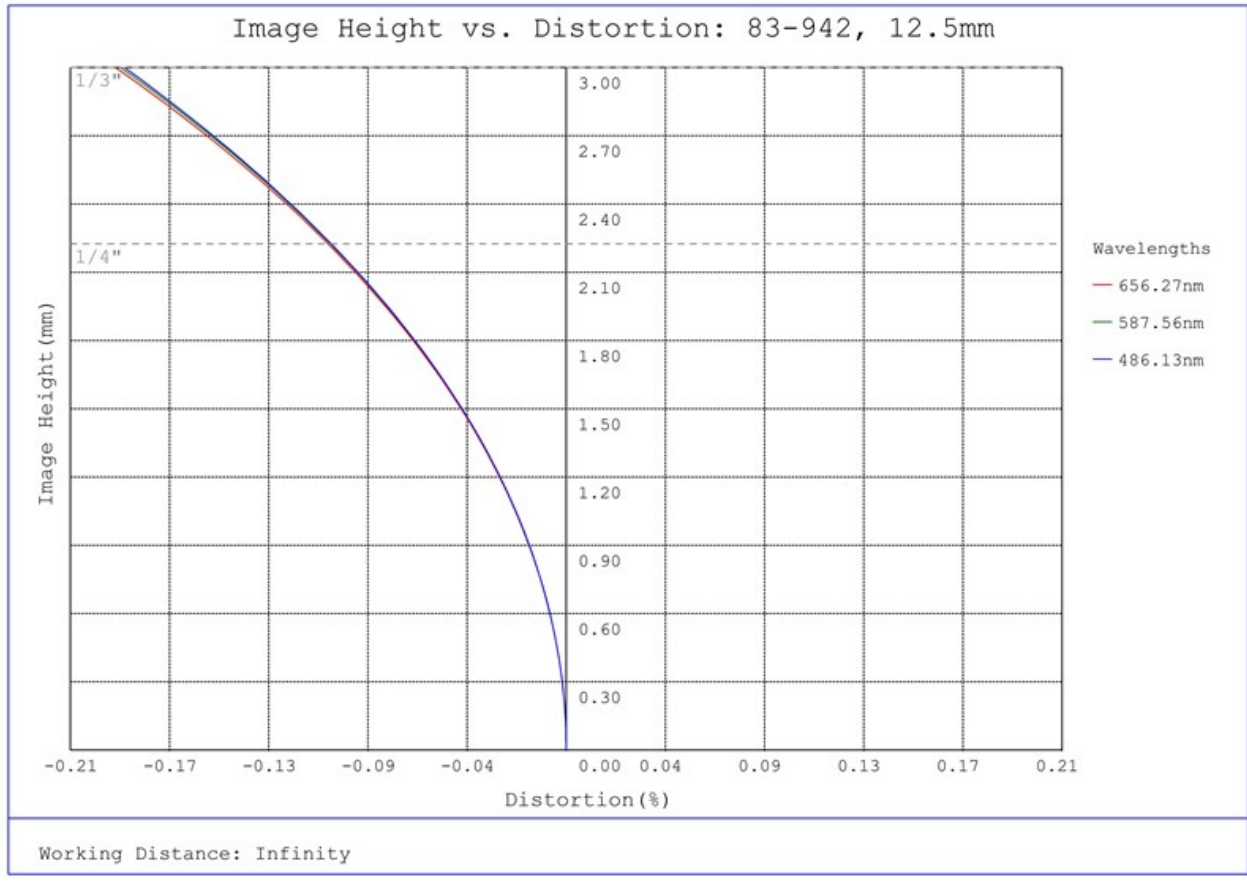

#83-942, 12.5mm FL f/5.6, Blue Series M12 Lens, Distortion Plot

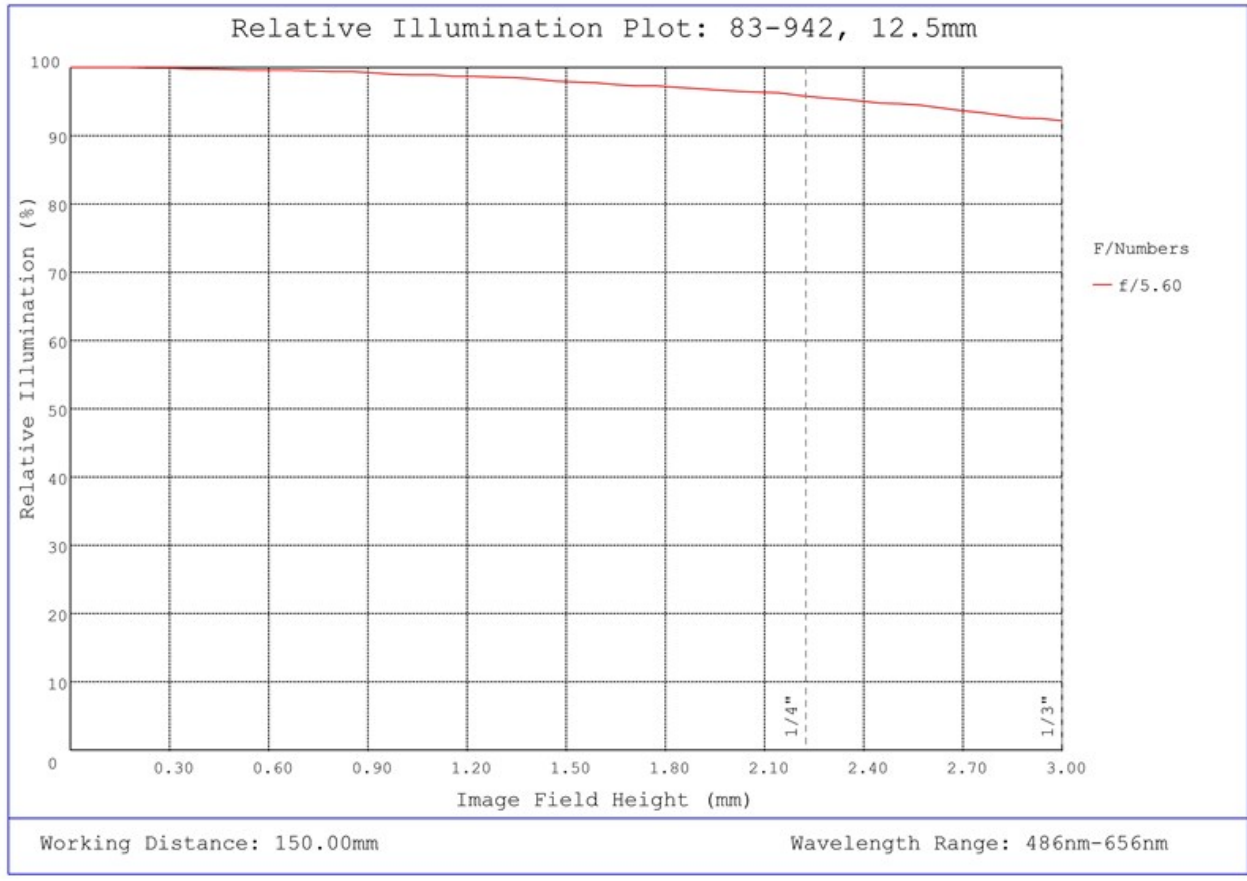

#83-942, 12.5mm FL f/5.6, Blue Series M12 Lens, Relative Illumination Plot

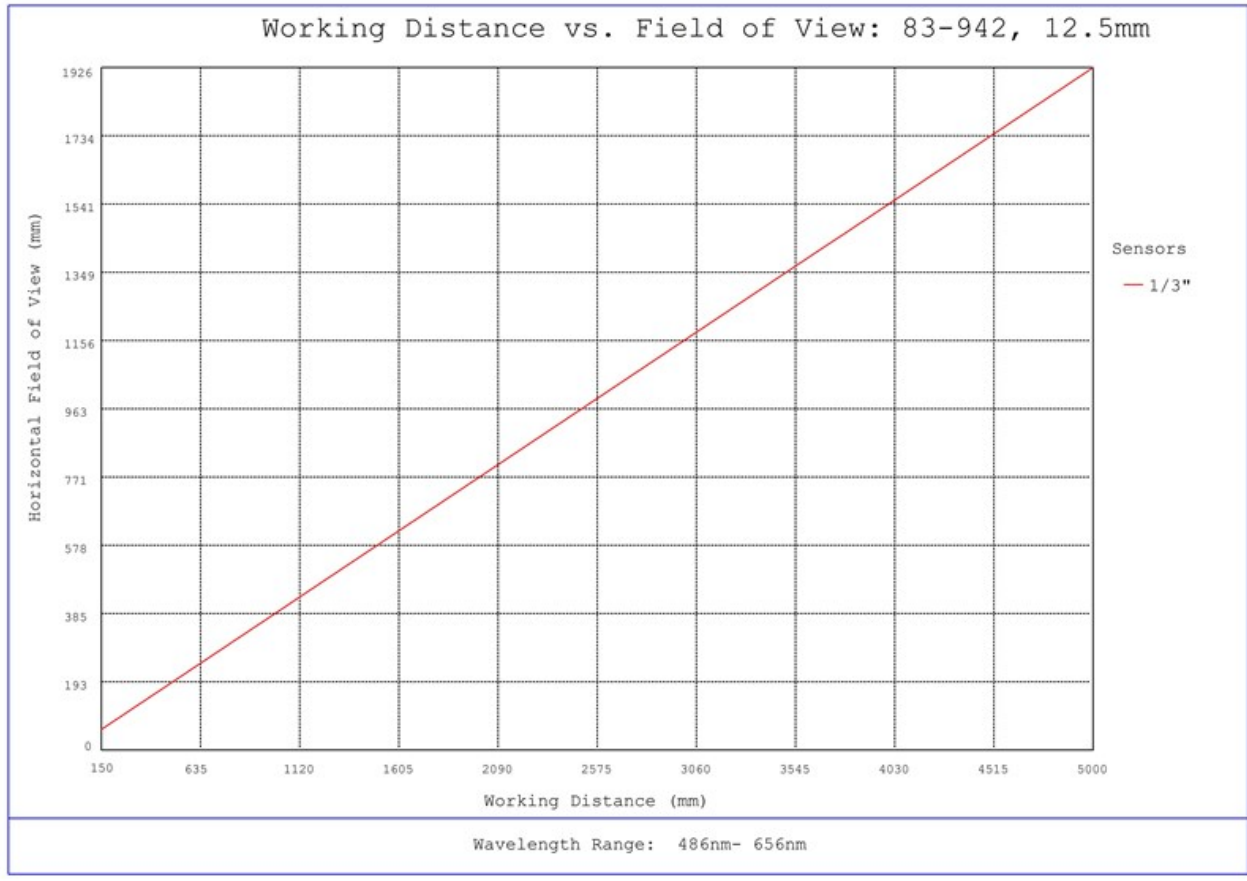

#83-942, 12.5mm FL f/5.6, Blue Series M12 Lens, Working Distance versus Field of View Plot

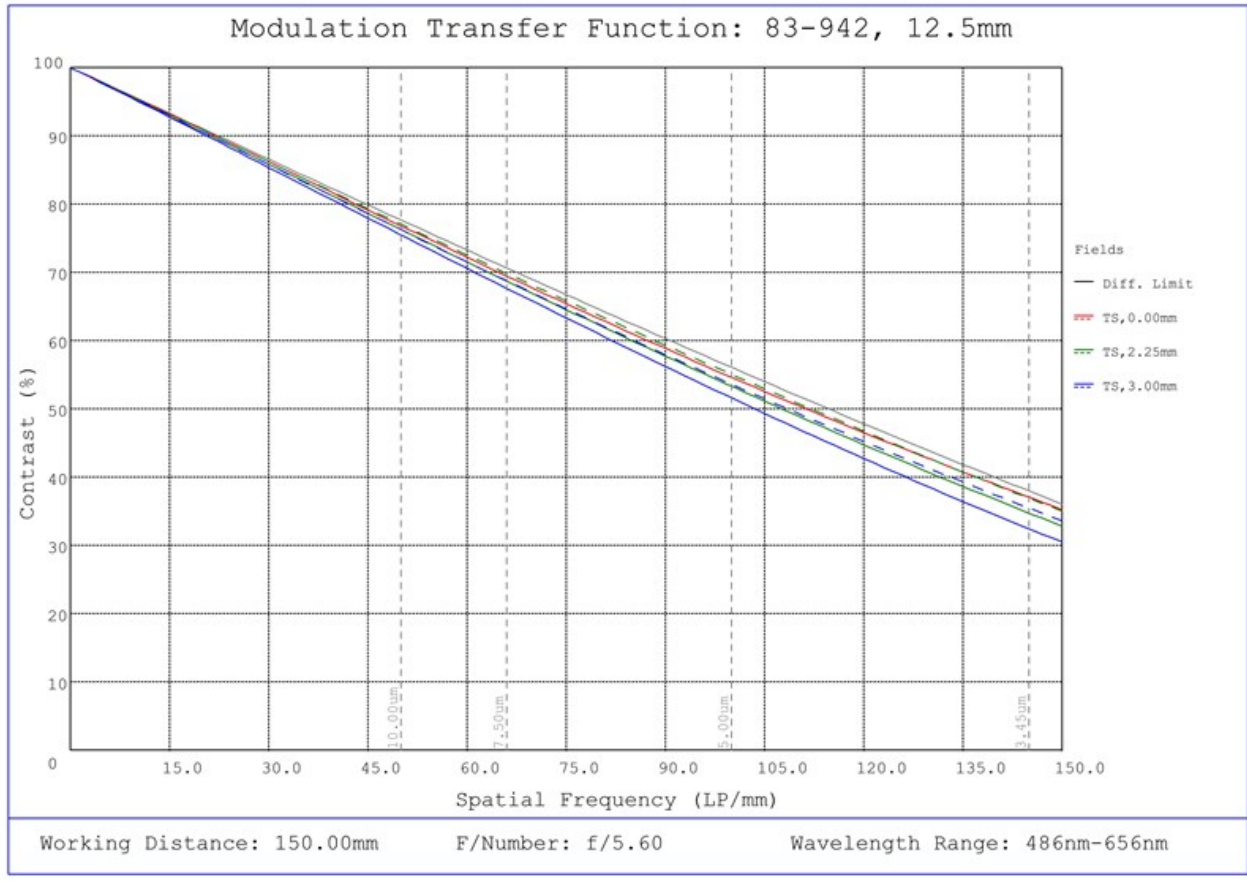

#83-942, 12.5mm FL f/5.6, Blue Series M12 Lens, Modulated Transfer Function (MTF) Plot, 150mm Working Distance, f5.6

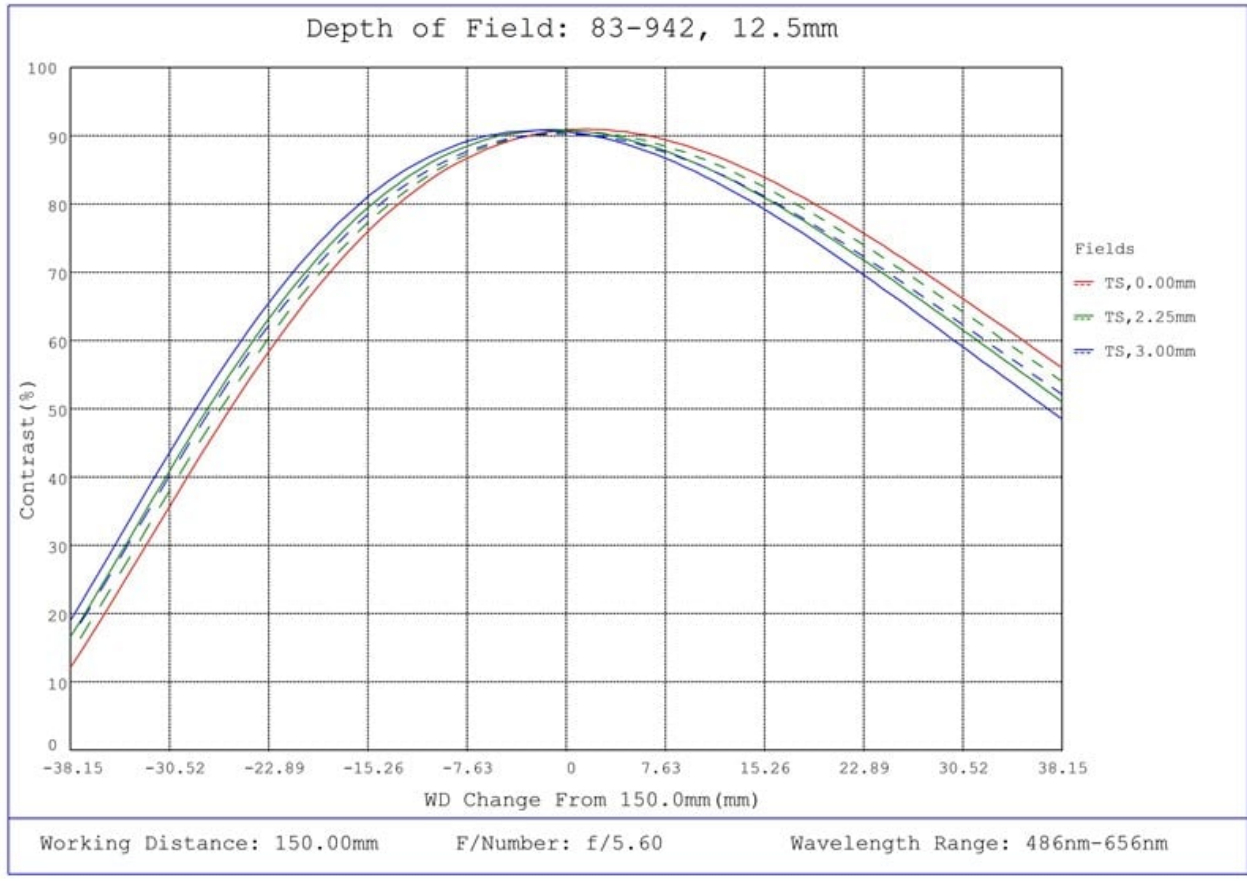

#83-942, 12.5mm FL f/5.6, Blue Series M12 Lens, Depth of Field Plot, 150mm Working Distance, f5.6

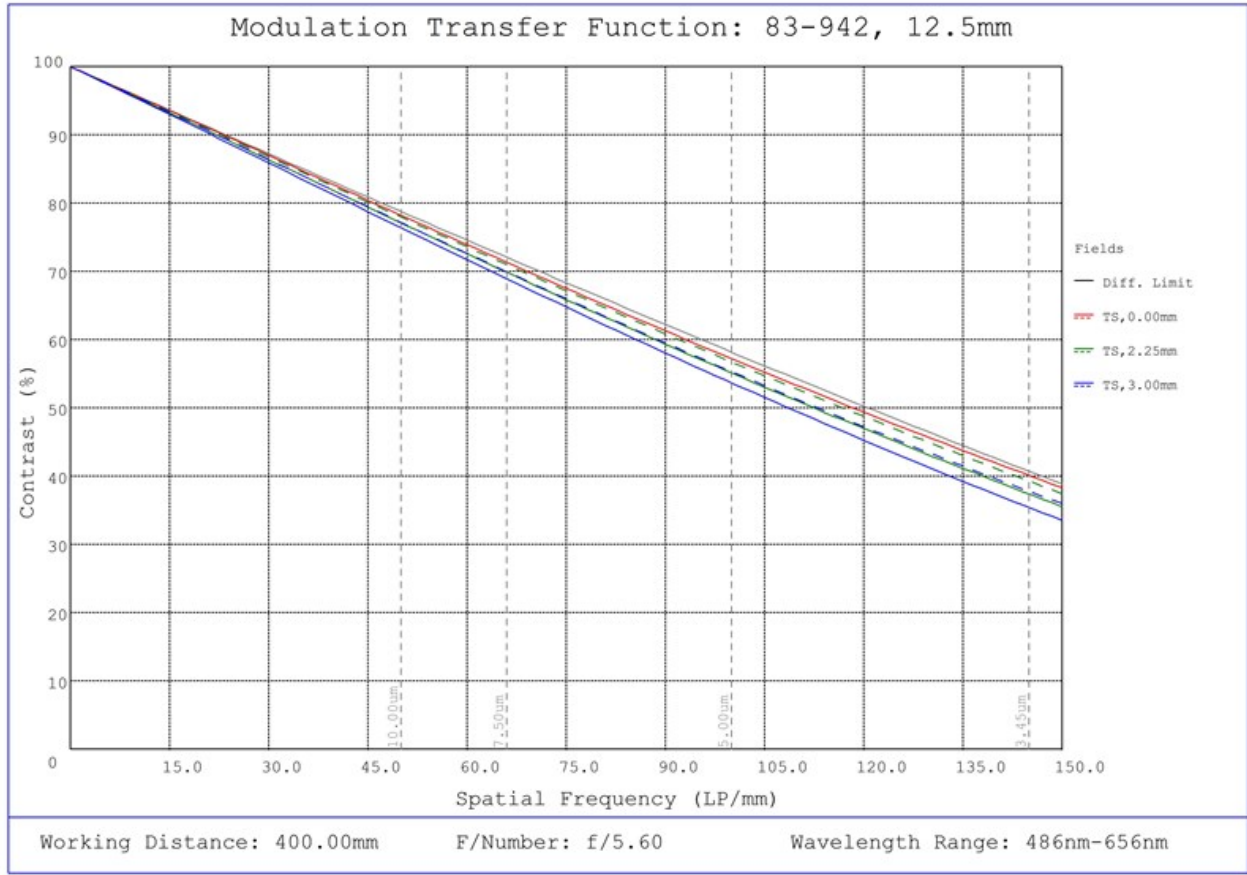

#83-942, 12.5mm FL f/5.6, Blue Series M12 Lens, Modulated Transfer Function (MTF) Plot, 400mm Working Distance, f5.6



#83-942, 12.5mm FL f/5.6, Blue Series M12 Lens, Depth of Field Plot, 400mm Working Distance, f5.6



September 08, 2023

To Whom It May Concern,

This document certifies that the product stated below has been reviewed as requested by Edmund Optics:

<i>Stock No.</i>	<i>Description</i>
83-942	12.5mm FL f/5.6, Blue Series M12 Lens

This item is EU RoHS (2015/863/EU) compliant without the use of exemptions.

This certification means that:

- EO's suppliers have confirmed the material composition of this product.
- EO has implemented rigorous procedures to document this compliance.
- The information provided may, or may not, be based upon actual test data, or on information from our Vendors, Raw Material Suppliers or Subcontractors.



Jay Budd, Director of Corporate Compliance
September 08, 2023

Edmund Optics Inc. - 101 E Gloucester Pike, Barrington, NJ 08007 | 1-800-363-1992 | Compliance@edmundoptics.com



September 08, 2023

To Whom It May Concern,

This document certifies that the product stated below has been reviewed as requested by Edmund Optics:

<i>Stock No.</i>	<i>Description</i>
83-942	12.5mm FL f/5.6, Blue Series M12 Lens

This item does not contain any of the substances listed on the Reach SVHC list as of 17 January 2022 in quantities exceeding 0.1% weight by weight.

Please note the following:

- Entry 11 of Annex V of the REACH regulation as amended by regulation 987/2008, exempts “non-hazardous” glass components from registration.
- Items considered to be packing materials and which do not form part of, or are not required for the operation of, the product, are not considered to be within scope of this declaration.
- EO does not routinely analyze products for substances not purposely added or specified within the design specifications, drawings and assembly procedures.

This certification means that:

- EO's suppliers have confirmed the material composition of this product.
- EO has implemented rigorous procedures to document this compliance.
- The information provided may, or may not, be based upon actual test data, or on information from our Vendors, Raw Material Suppliers or Subcontractors.



Jay Budd, Director of Corporate Compliance
September 08, 2023

Edmund Optics Inc. - 101 E Gloucester Pike, Barrington, NJ 08007 | 1-800-363-1992 | Compliance@edmundoptics.com



September 08, 2023

<i>Stock No.</i>	<i>Description</i>
83-942	12.5mm FL f/5.6, Blue Series M12 Lens

Edmund Optics certifies that all articles included in this shipment are in compliance with the terms and conditions of this order. The company also certifies that the articles included in this shipment are in accordance to all agreed upon specifications and quality assurance provisions. Please call 1-800-363-1992 should any questions arise from this shipment.



Jeff Harvey- EVP of Operations

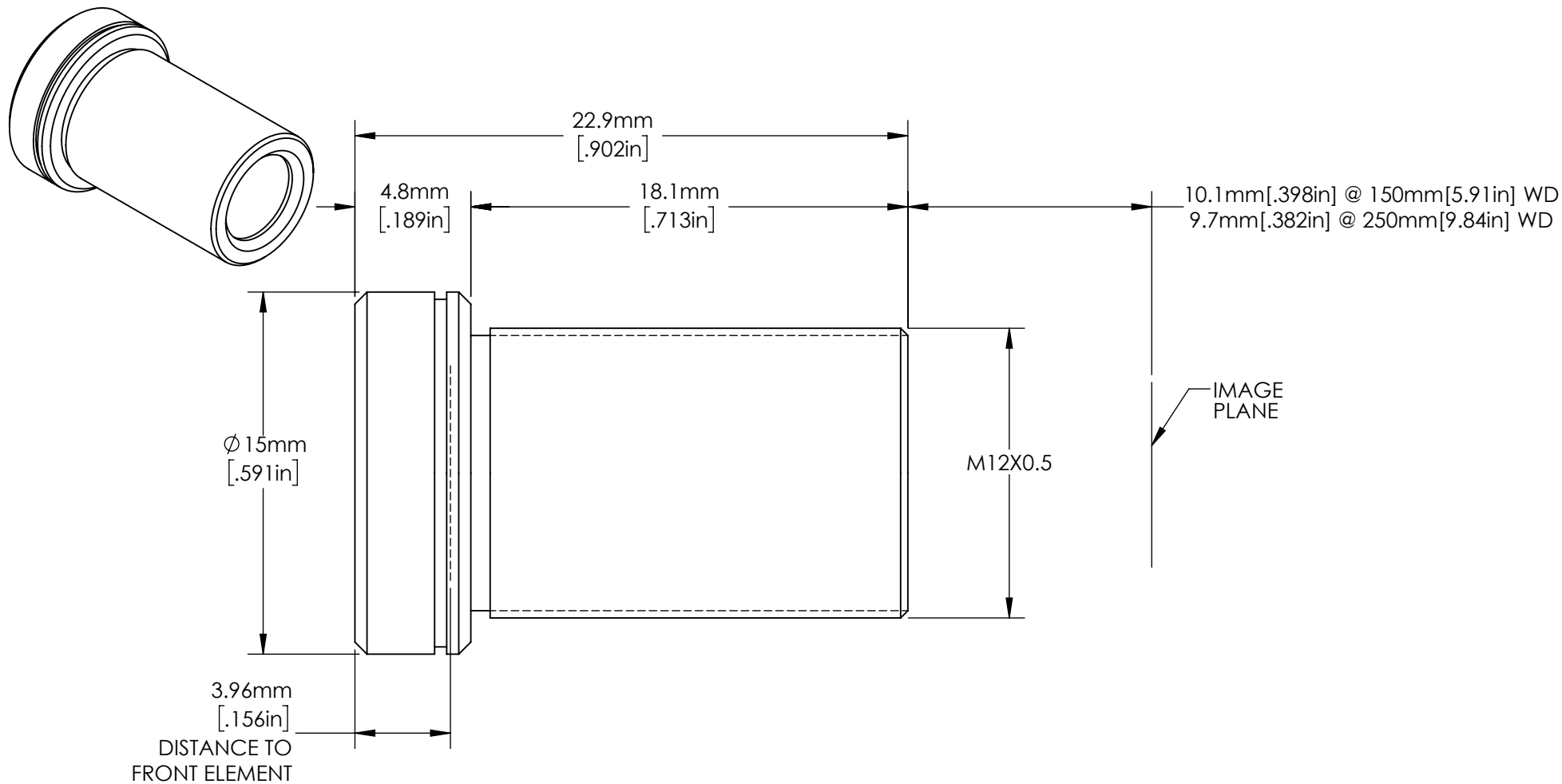

FOR INFORMATION ONLY:
DO NOT MANUFACTURE
PARTS TO THIS DRAWING

SPECIFICATIONS SUBJECT TO CHANGE
 WITHOUT NOTICE.
 DIMENSIONS ARE FOR REFERENCE ONLY.
 FOR DETAILED SPECIFICATIONS,
 PLEASE REFER TO THE SPEC SHEET.

EO® Edmund Optics®

TITLE	12.5mm FL f/5.6, Blue Series M12 μ -Video™ Imaging Lens		
DWG NO	83942		SHEET 1 OF 1

