

# ML-M1218UR

## ML-M-UR series



Drawing No. A23043

		Lens Type	CCTV Lens	
		Focus Position	Reference Magnification	M.O.D
		Magnification	0.023	0.075
(mm)		Focal Length	12.00	12.00
Fno		Fno	1.80	16.00
NA		Numerical Aperture	-	-
WD/OD (mm)		Working/Object Distance	500.0 / 505.6	150.0 / 155.0
O/I (mm)		Object to Image Distance	559.55	209.55
(mm)		Mechanical Tube Length	39.20	40.10
(mm)		Lens Back	12.23	12.84
(mm)		DOF @PCoC 0.04mm	277.576	28.121
( $\mu$ m)		Resolution @ $\lambda=550$ nm	-	-
/	(mm)	Front/Rear Principal Position	17.71 / -0.05	17.71 / -0.05
/	(mm)	Entrance/Exit Pupil Position	11.68 / -12.18	11.68 / -12.18
/	(mm)	Entrance/Exit Pupil Diameter	6.67 / 13.41	6.67 / 13.41
(deg.)	H x V	Angle Of View	40.54 x 30.77	39.40 x 30.05
TV	(%)	TV Distortion	-0.983	-0.905
	(%)	Relative Illumination	40.64	42.64
(g)		Weight	60	
		Mount	C mount	
	(mm)	Image Circle	11	
		Largest Compatible Camera	2/3 Inch	

### ML-M1218UR

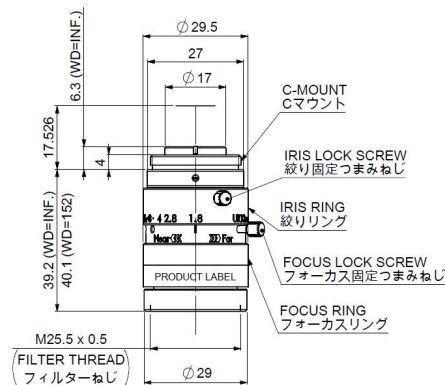

### WD=500.0mm Fno2.8

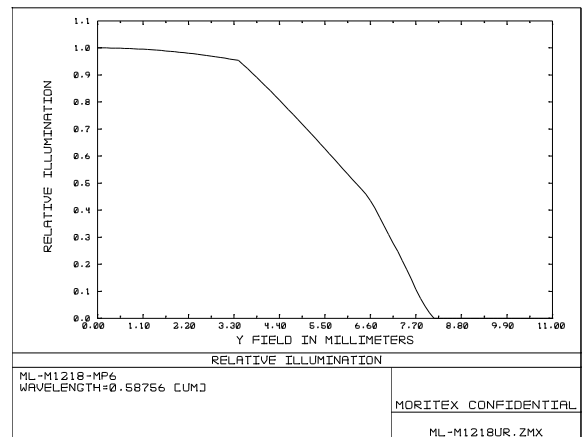
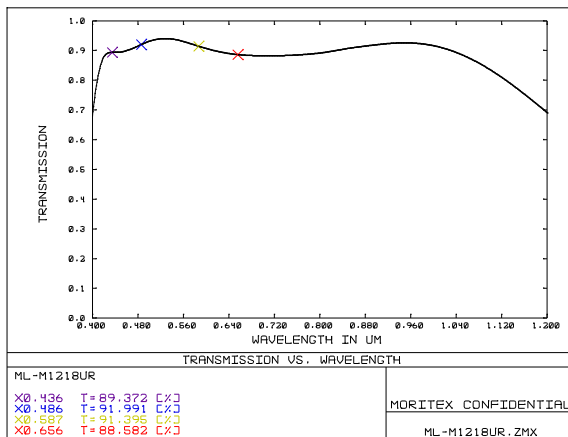
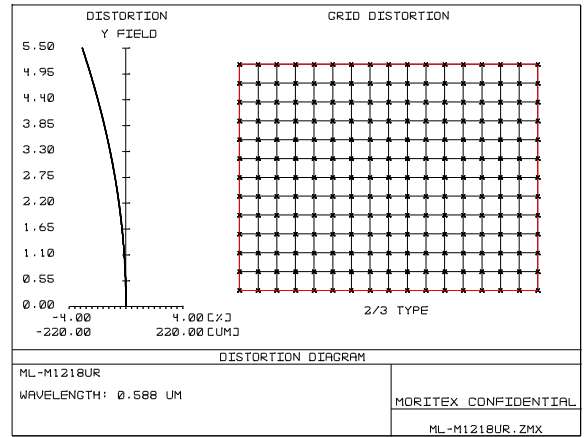
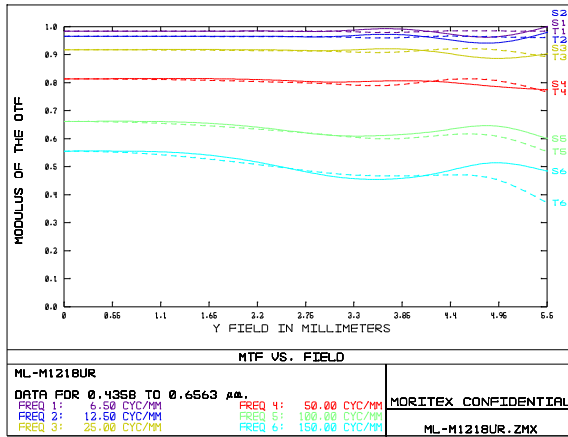

The content is subject to change at any time without notification.

株式会社 **モリテックス** MORITEX Corporation

Technology center Lens design & Development technology

TEL +81 (0)48-218-2536 moritex.mvs@moritex.com

FAX +81 (0)48-462-6713 www.moritex.com



### WD=300.0mm Fno2.8

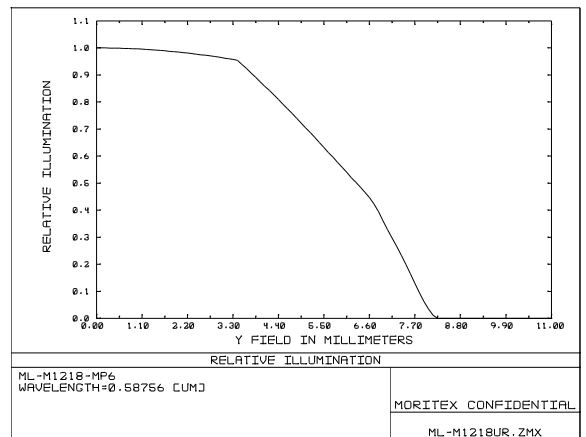
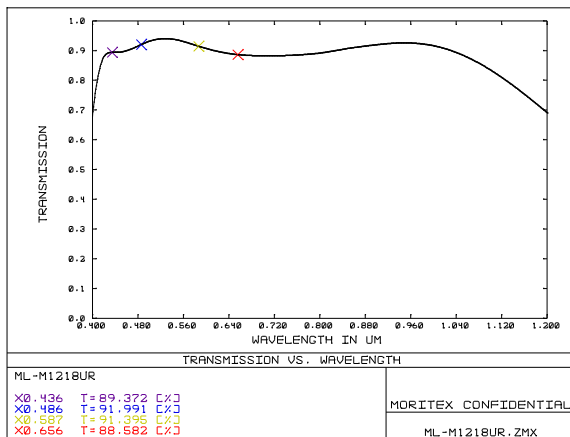
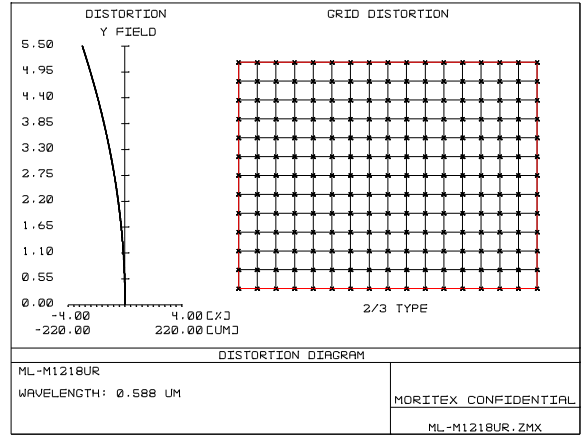
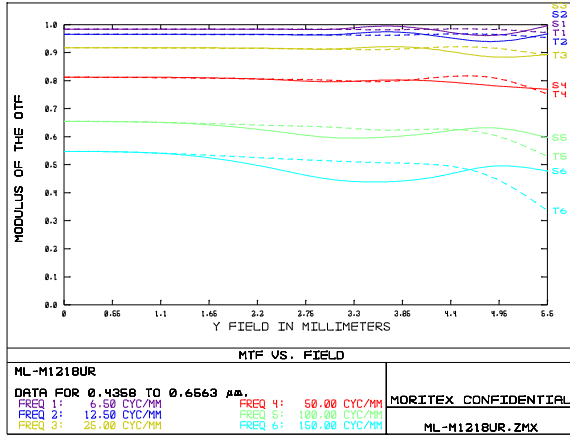

The content is subject to change at any time without notification.

株式会社 **モリテックス** MORITEX Corporation

Technology center Lens design & Development technology

TEL +81 (0)48-218-2536 moritex.mvs@moritex.com

FAX +81 (0)48-462-6713 www.moritex.com



### WD=150.0mm Fno2.8

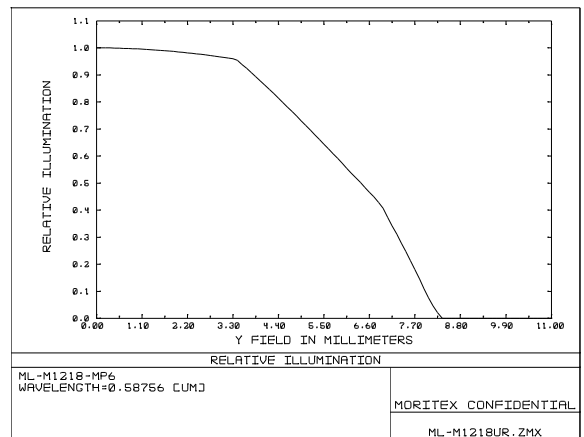
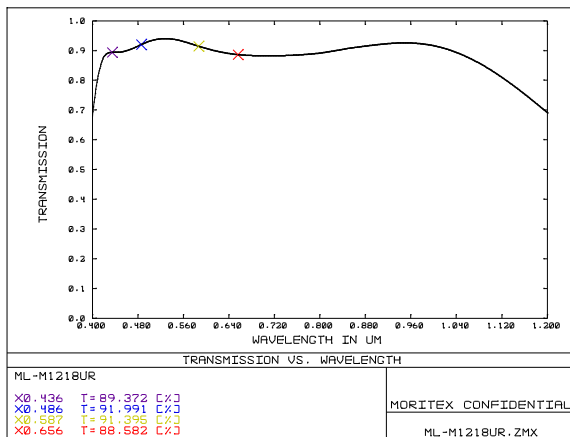
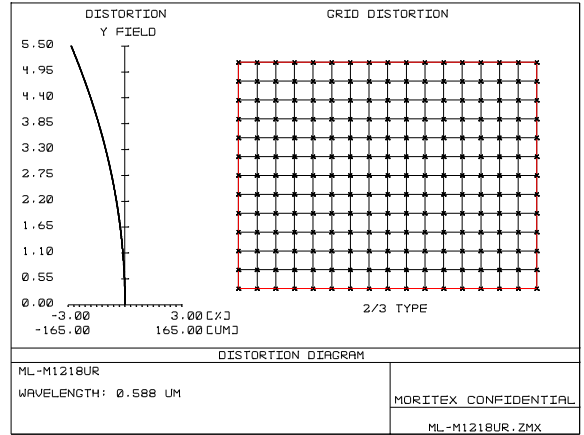
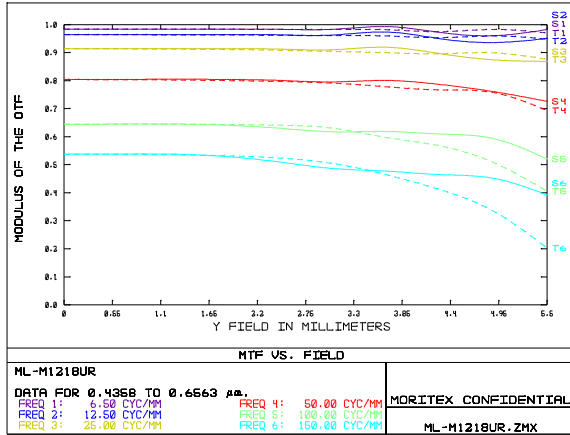

The content is subject to change at any time without notification.

株式会社 **モリテックス** MORITEX Corporation

Technology center Lens design & Development technology

TEL +81 (0)48-218-2536 moritex.mvs@moritex.com

FAX +81 (0)48-462-6713 www.moritex.com

