

ML-U1615SR-18C

ML-U-SR series



Drawing No. A23497

		Lens Type	CCTV Lens	
		Focus Position	Reference Magnification	M.O.D
		Magnification	0.032	0.142
(mm)		Focal Length	16.30	16.56
Fno		Fno	1.58	16.00
NA		Numerical Aperture	-	-
WD/OD (mm)		Working/Object Distance	500.0 / 503.5	100.0 / 103.5
O/I (mm)		Object to Image Distance	584.46	184.46
(mm)		Mechanical Tube Length	67.00	
(mm)		Lens Back	14.61	16.55
(mm)		DOF @PCoC 0.04mm	136.745	6.953
(μ m)		Resolution @ $\lambda=550$ nm	-	-
/	(mm)	Front/Rear Principal Position	29.94 / -2.16	29.56 / -2.32
/	(mm)	Entrance/Exit Pupil Position	17.52 / -54.32	17.00 / -54.32
/	(mm)	Entrance/Exit Pupil Diameter	10.02 / 42.09	10.16 / 42.09
(deg.)	H x V	Angle Of View	47.17 \times 36.08	45.12 \times 34.70
TV	(%)	TV Distortion	-0.857	-0.833
	(%)	Relative Illumination	37.26	39.75
(g)		Weight	182	
		Mount	C mount	
(mm)		Image Circle	17.6	
		Largest Compatible Camera	1.1 Inch	

ML-U1615SR-18C

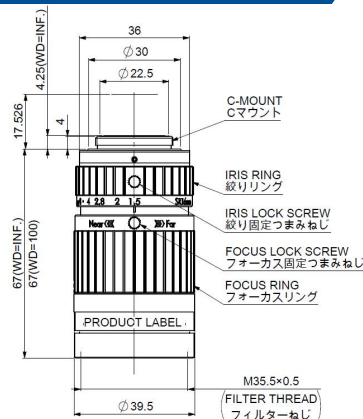

WD=500.0mm Fno2.8

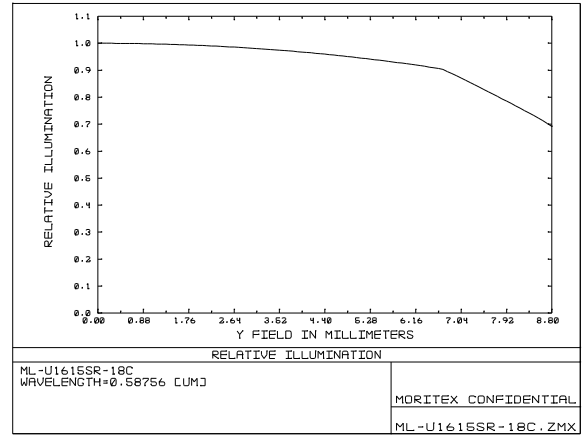
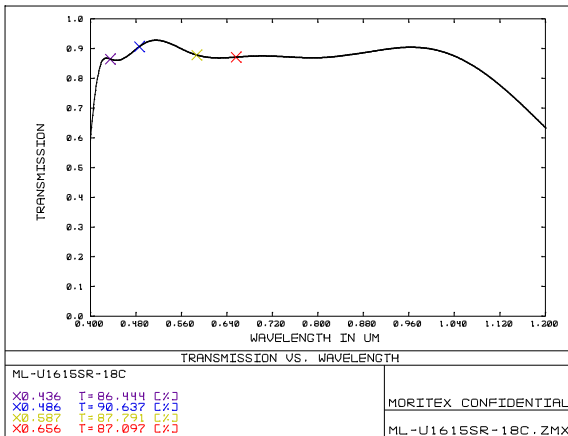
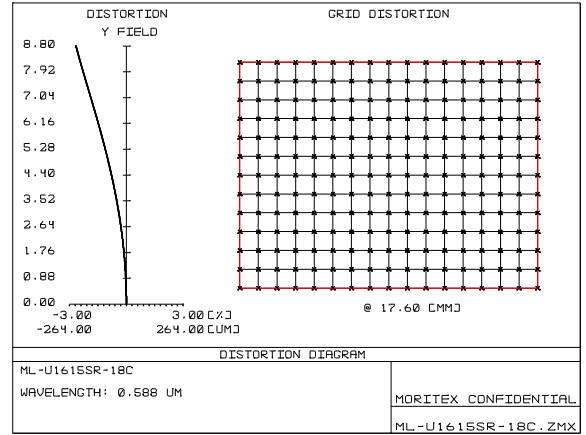
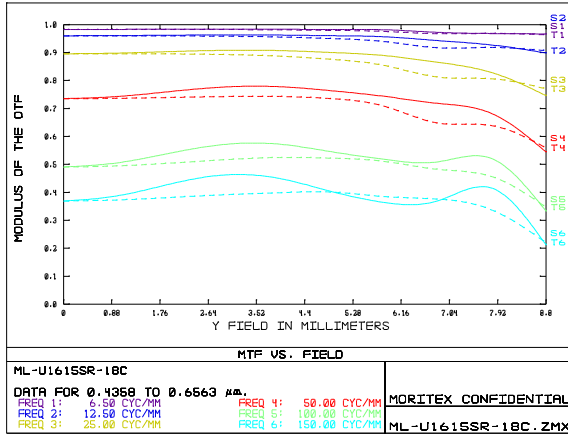

The content is subject to change at any time without notification.

株式会社 モリテックス MORITEX Corporation

Technology center Lens design & Development technology

TEL +81 (0)48-218-2536 moritex.mvs@moritex.com

FAX +81 (0)48-462-6713 www.moritex.com



WD=300.0mm Fno2.8

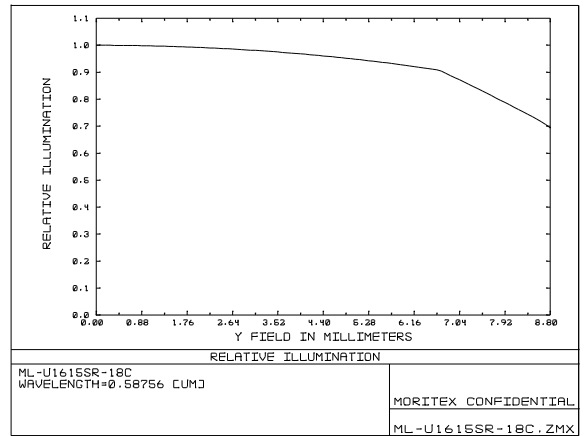
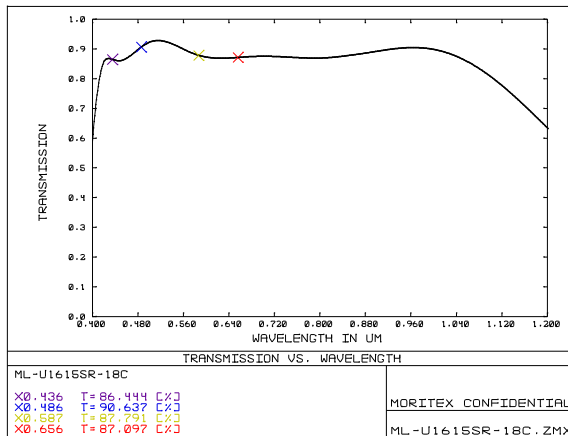
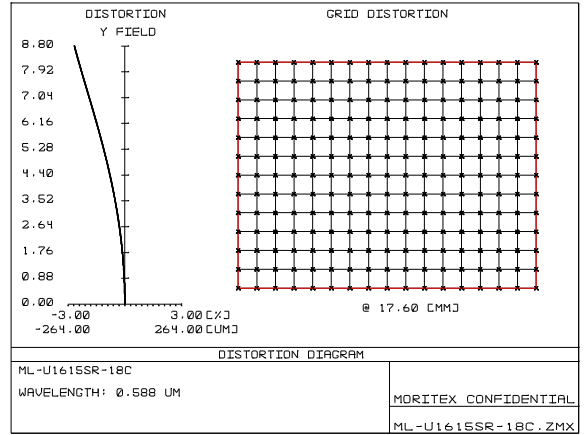
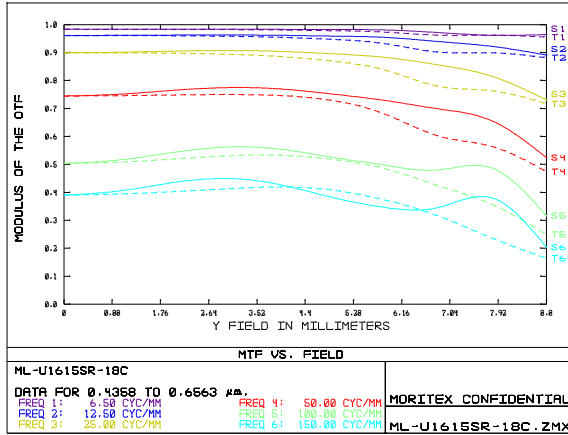

The content is subject to change at any time without notification.

株式会社 **モリテックス** MORITEX Corporation

Technology center Lens design & Development technology

TEL +81 (0)48-218-2536 moritex.mvs@moritex.com

FAX +81 (0)48-462-6713 www.moritex.com



WD=100.0mm Fno2.8

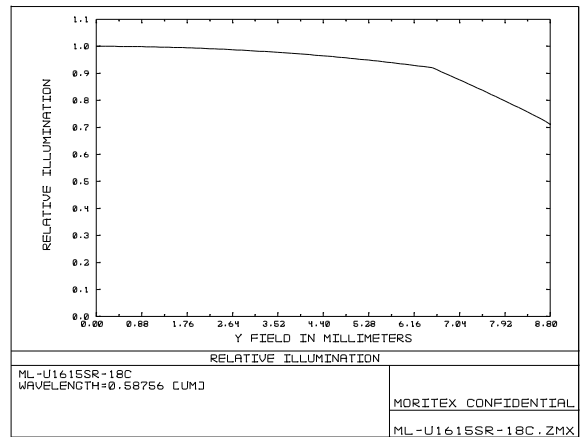
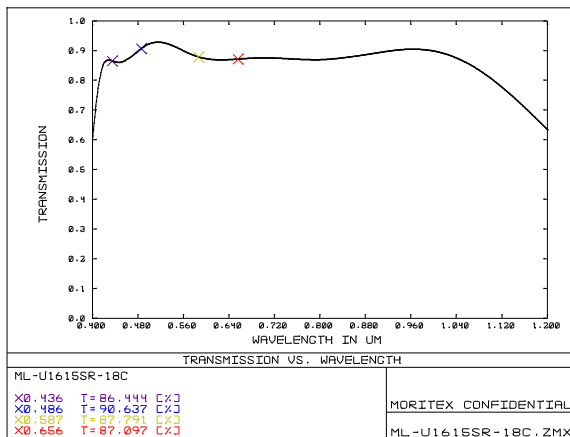
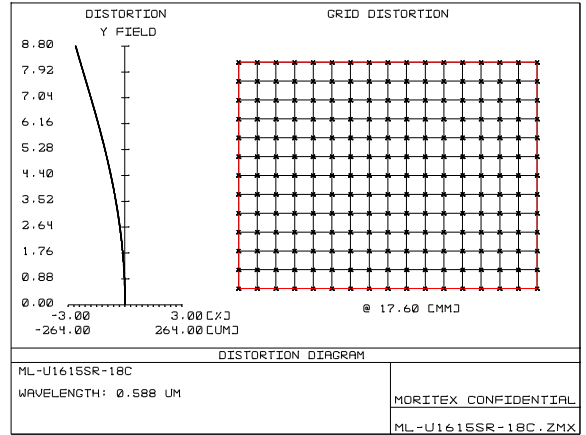
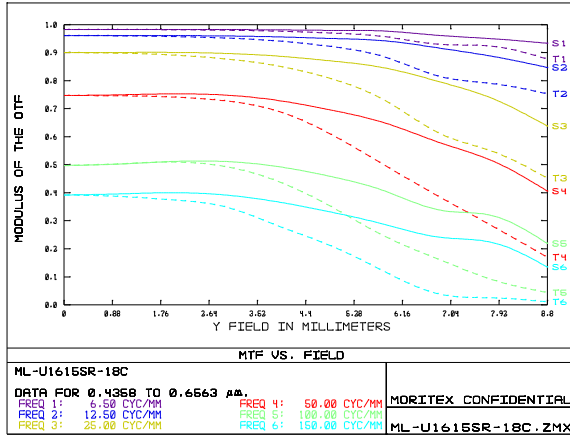

The content is subject to change at any time without notification.

株式会社 モリテックス MORITEX Corporation

Technology center Lens design & Development technology
 TEL +81 (0)48-218-2536 moritex.mvs@moritex.com
 FAX +81 (0)48-462-6713 www.moritex.com

