

LTCLCR080-W | DATASHEET

Telecentric CORE illuminator, beam dimension $\varnothing=98.0$, $x=90.0$ mm, white



KEY ADVANTAGES

Deliver excellent performances

LTCLHP CORE telecentric illuminators deliver exactly the same excellent optical performances as other Opto Engineering® telecentric illuminators.

Downsize your vision system

LTCLHP CORE telecentric illuminators are up to 60% smaller than other telecentric illuminators on the market.

Easy retrofitting into existing systems

LTCLHP CORE illuminators can be mounted in different directions in your machine.

Improve your system performances

LTCLHP CORE illuminators may be used instead of flat backlights to improve your system.

Cut costs and sell more

A smaller system means less expenses and less space and is preferred by the industry.

Homogeneity test report with measured values

The **LTCLHP CORE Series** offers ultra compact telecentric illuminators. They are up to 60% more compact than other collimated illuminators on the market.



SPECIFICATIONS

Lighting specifications

Beam dimension ¹	(mm)	$\varnothing=98.0$, $x=90.0$
Working distance	(mm)	150 - 300
Light color, peak wavelength ²		white, 6000 K
Spectral FWHM	(nm)	-

Electrical specifications

Supply voltage ³	(V)	12-24
Max power consumption	(W)	2.5
Led forward voltage typical (max) ⁴	(V)	2.8 (-)
Max led forward current ⁵	(mA)	350
Max pulse current ⁶	(mA)	2000
Connector		M8
Included cable		CB244P1500

Mechanical specifications

A	(mm)	118.9
B	(mm)	145.0
C ⁷	(mm)	158.4
Mass	(g)	2934

Environment

Operating temperature	(°C)	0-40
Storage temperature	(°C)	0-50
Operating relative humidity	(%)	20-85, non condensing
Installation		Indoor use only

Eye safety

Risk group (CEI EN 62471:2010)	Risk group 2
--------------------------------	--------------

¹ Beam shape is not circular.

² Opto Engineering recommends green light for high precision measurements application

³ Tolerance $\pm 10\%$

⁴ At max forward current. Tolerance is $\pm 0.06V$ on forward voltage measurements

⁵ In continuous mode (not pulsed)

⁶ At pulse with $\leq 10ms$ and duty cycle $\leq 10\%$. Built in electronics board must be bypassed.

⁷ Nominal value, with no spacers in place.

M8 CONNECTOR PINOUT

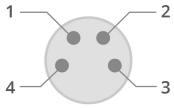

Device side

Pin	Function	Cable color
1	Earth	Yellow/Green
2	Ground	Black
3	Anode	Blue
4	Power supply (+12/24 V)	Brown

COMPATIBLE PRODUCTS

Full list of compatible products available [here](#).



A wide selection of innovative machine vision components.

BEAM SHAPE

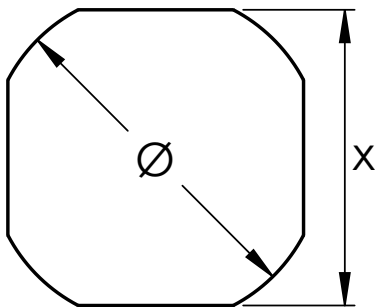

LTCLHP CORE illuminator dimensions (A, B, C)

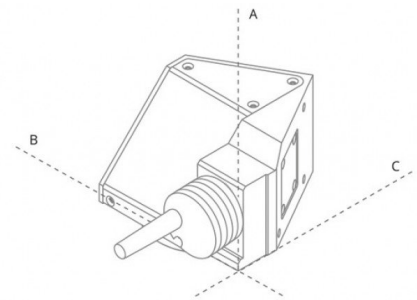

LED color spectrum

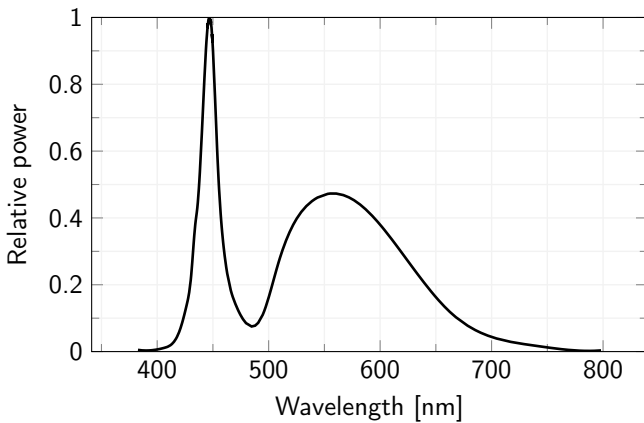

Forward Current Characteristics

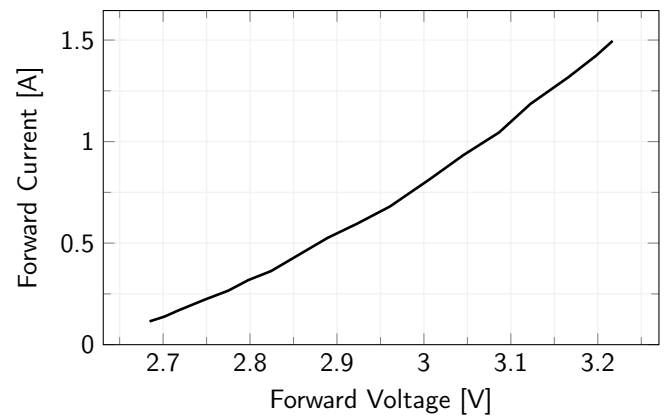

All product specifications and data are subject to change without notice to improve reliability, functionality, design or other. Photos and pictures are for illustration purposes only. Data are reported by design, actual lens performance may vary due to manufacturing tolerances.